



Un algoritmo olistico per la progettazione di comunità energetiche

Davide Fioriti, Dimitri Thomopoulos
DESTEC, Università di Pisa

Energy communities



Cooperation



for a sustainable future

The transition of the power system

Yesterday

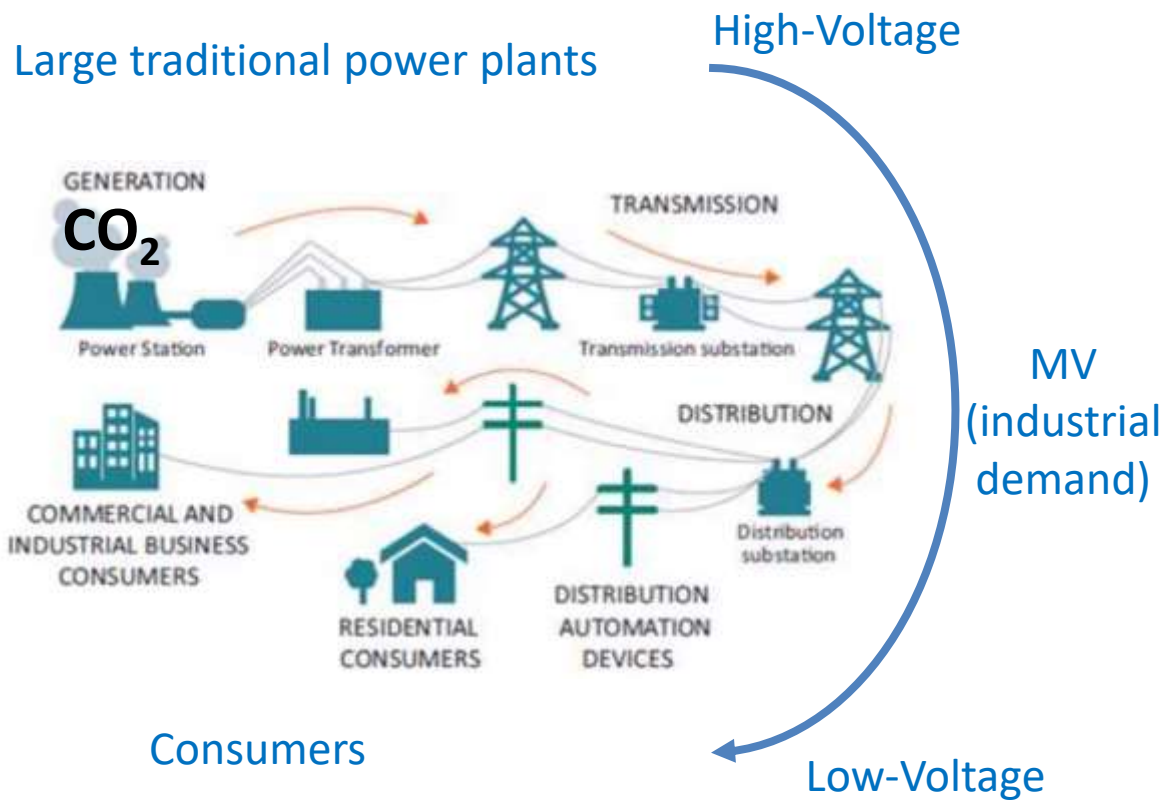

Today and tomorrow

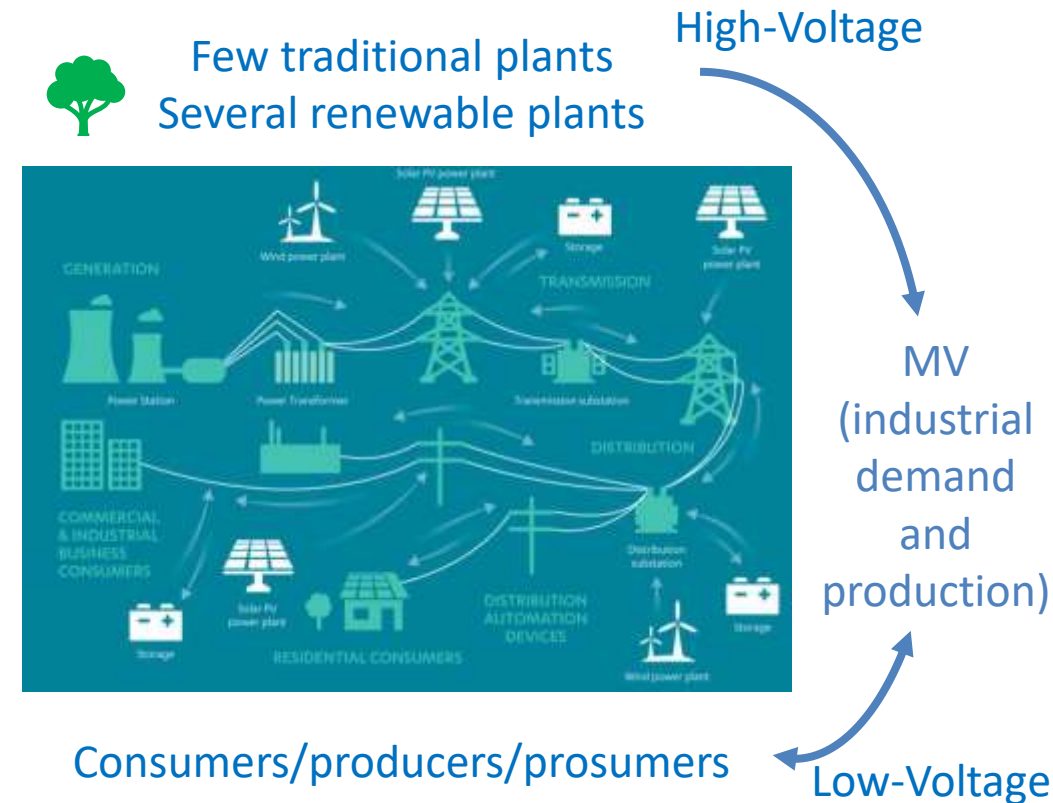

The power system is becoming bidirectional, not without challenges

Limits for the decarbonization - today

Netherlands is not accepting new large renewable power plants

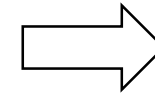
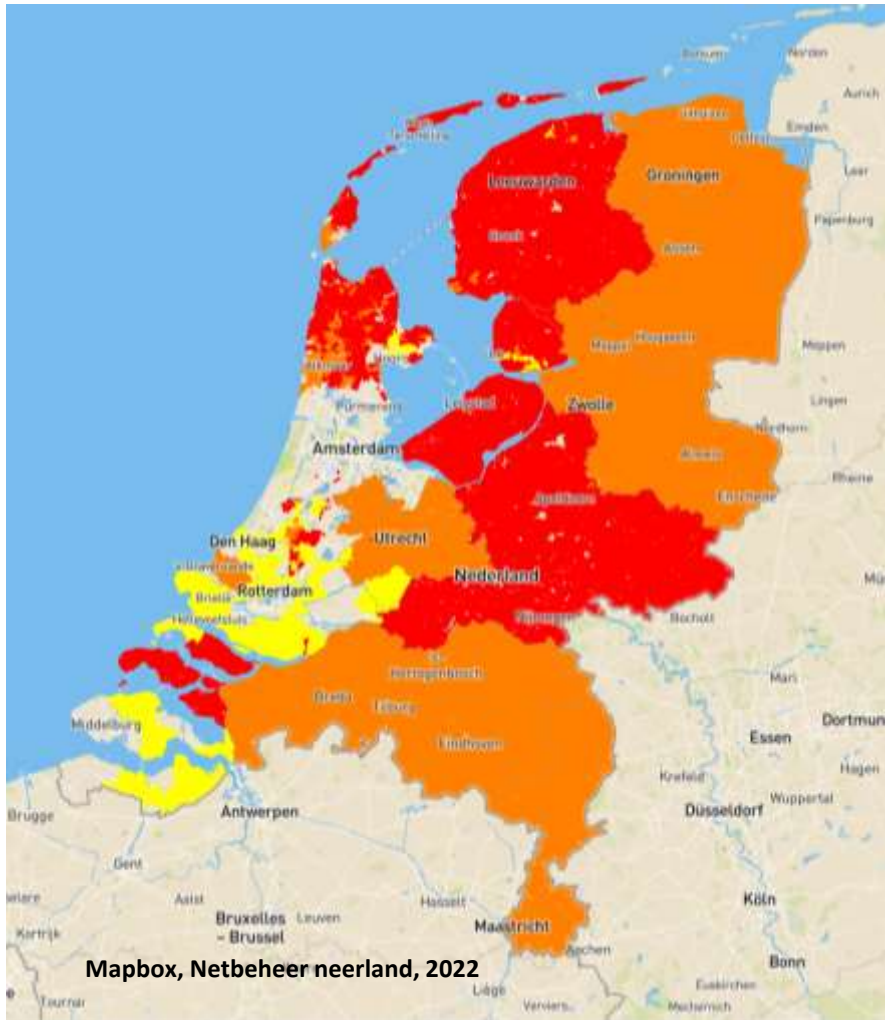

Need for:

- **Investments in infrastructure**
- **Decentralized systems**
- **Coordination** between local demand and production



Energy Communities:
part of the solution



Energy Communities: EU directives and Italian adoption



Renewable Energy Communities (REC)

Renewable Energy Directive 2018/2001/EU (RED II)

Citizen Energy Communities (CEC)

Internal Market in Electricity Directive 2019/944/EU (IEMD)

Objectives: environmental, social and lastly economic

Free participation, local ownership and no-profit scope

Italian regulation:

- Decree Milleproroghe 162/2016 – legge 8/2020
- Implementing acts 318/2020 ARERA and DM 16/9 2020 MiSE; D.lgs. 199/2021
- Implementing acts 120/2022 and 390/2022 ARERA

Energy Community: not just engineering ...



Real system

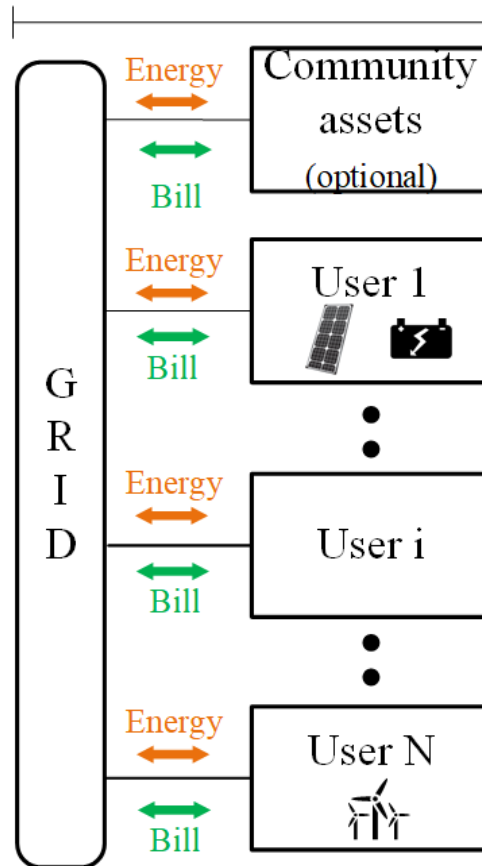

Energy Community: ... a multidisciplinary system

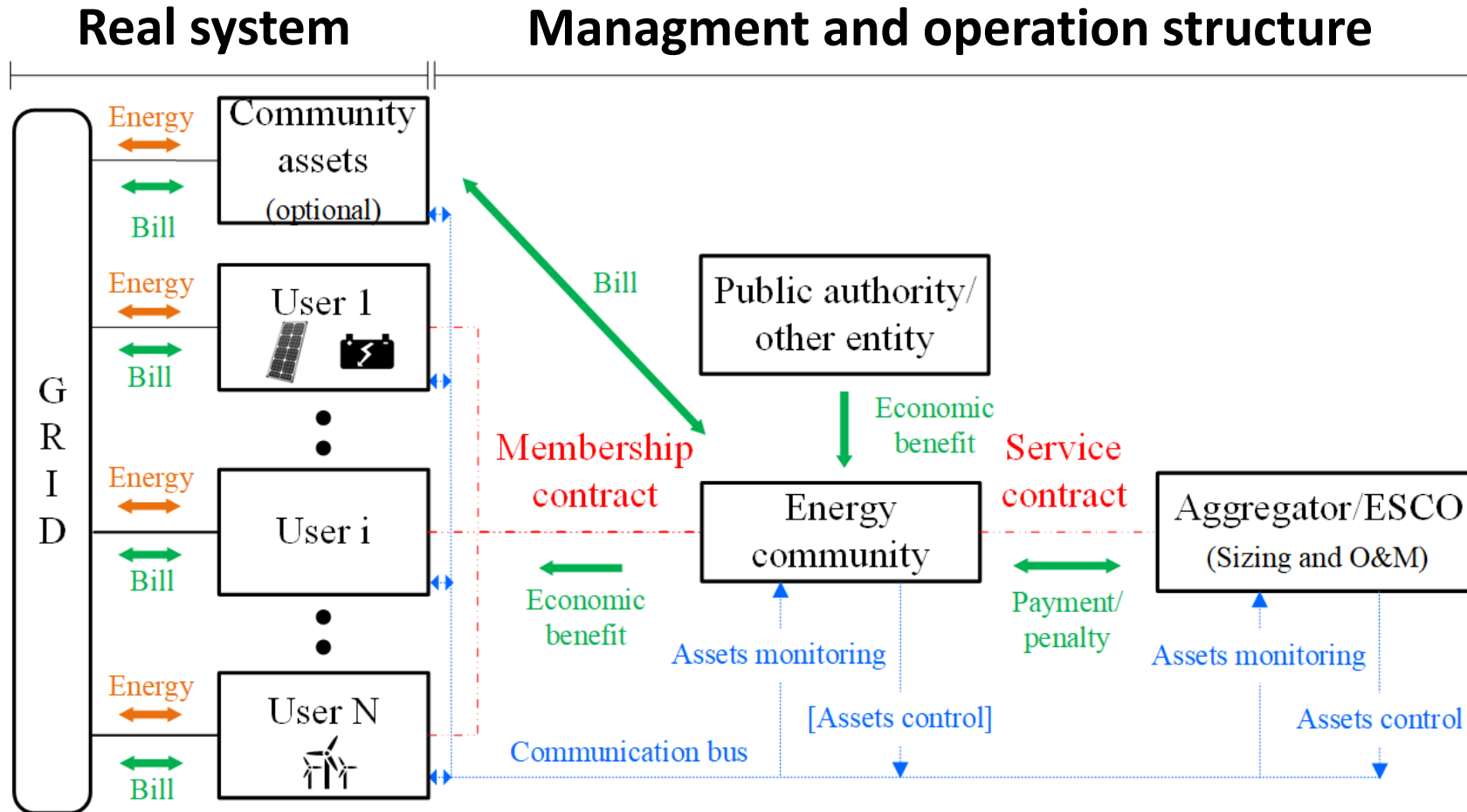

AUTENS approach: an holistic method to dominate complexity

Holistic model for Energy Communities



AUTENS

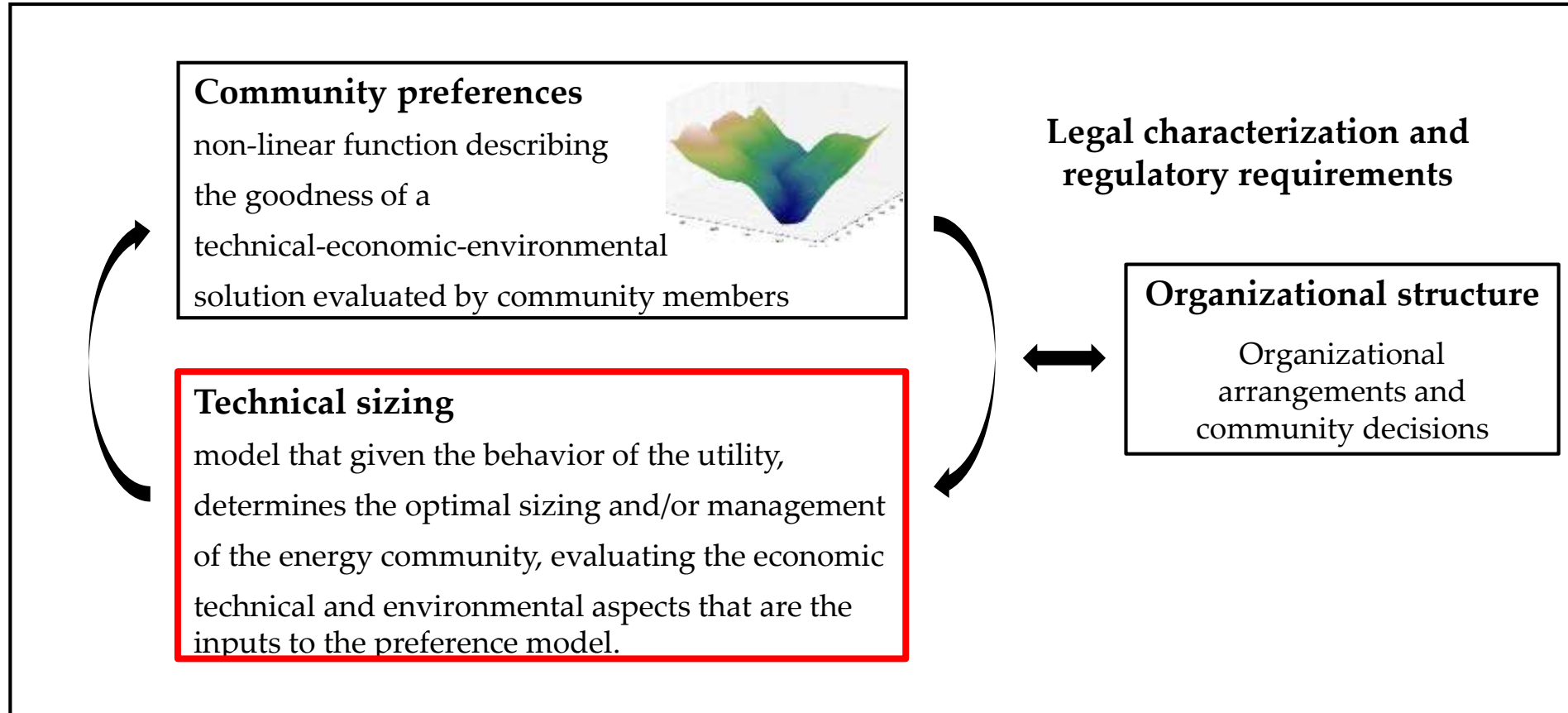

The technical method is influenced by organizational and legal framework: FOCUS



Holistic algorithm for Energy Communities design



- Decision support **tool** that can address the need to **design, develop, and manage** an **Energy Community**;
- Designed with philosophies of **parametricity, modularity, and flexibility**;
- High **interdisciplinarity** and **combination** of different management aspects.

Interdisciplinarity

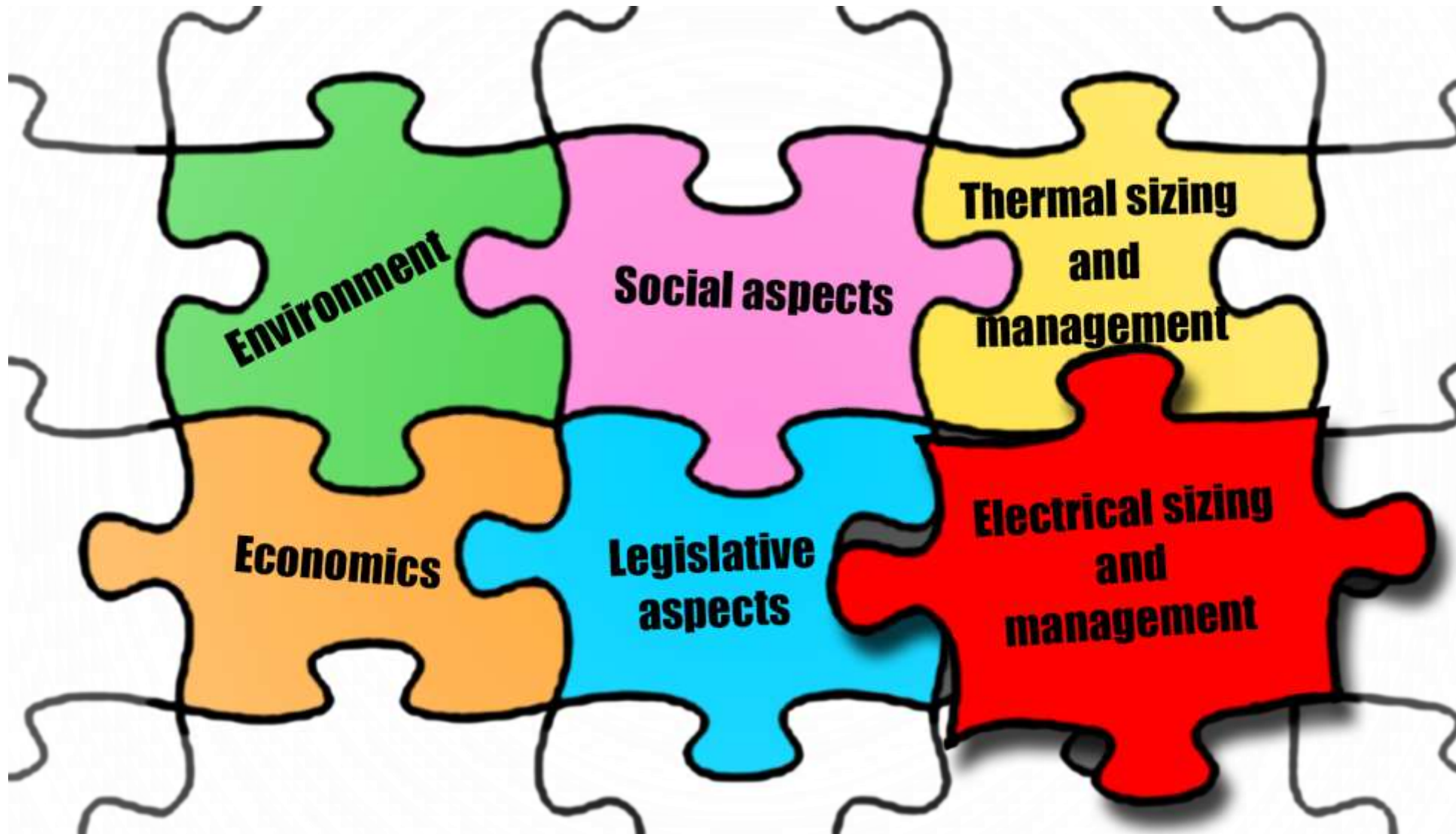

Operations Research

- **Operations Research** is subfield of mathematical sciences that deals with the development and application of analytical methods to improve **decision-making**.
- Two major sub-disciplines are:
 - **Simulation**, i.e., models and algorithms which attempts to **predict** the **behavior** of the system from a set of parameters and initial conditions;
 - **Optimization**, i.e., an analytical formulation that represents a problem through a **mathematical model** and allows to find the **optimal** solution.

Multiobjective optimization

- **Economic** objective function;
- **Environmental** objective function;
- **Social** objective function.



The Mind Illuminated: A Complete Meditation Guide Integrating Buddhist Wisdom and Brain Science for Greater Mindfulness, Atria Books, 2017.

Optimal Management



Optimal Management

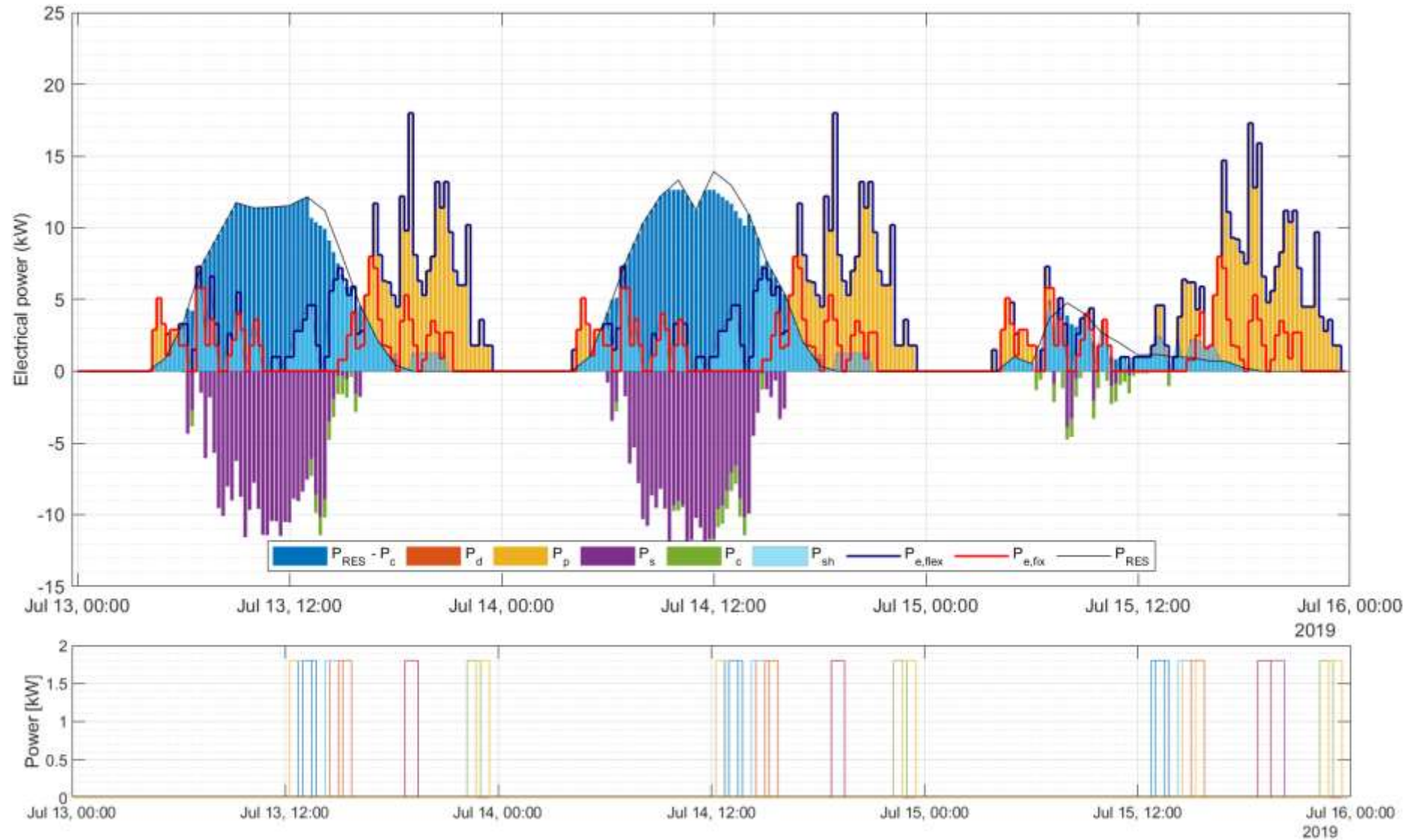

Pareto Front

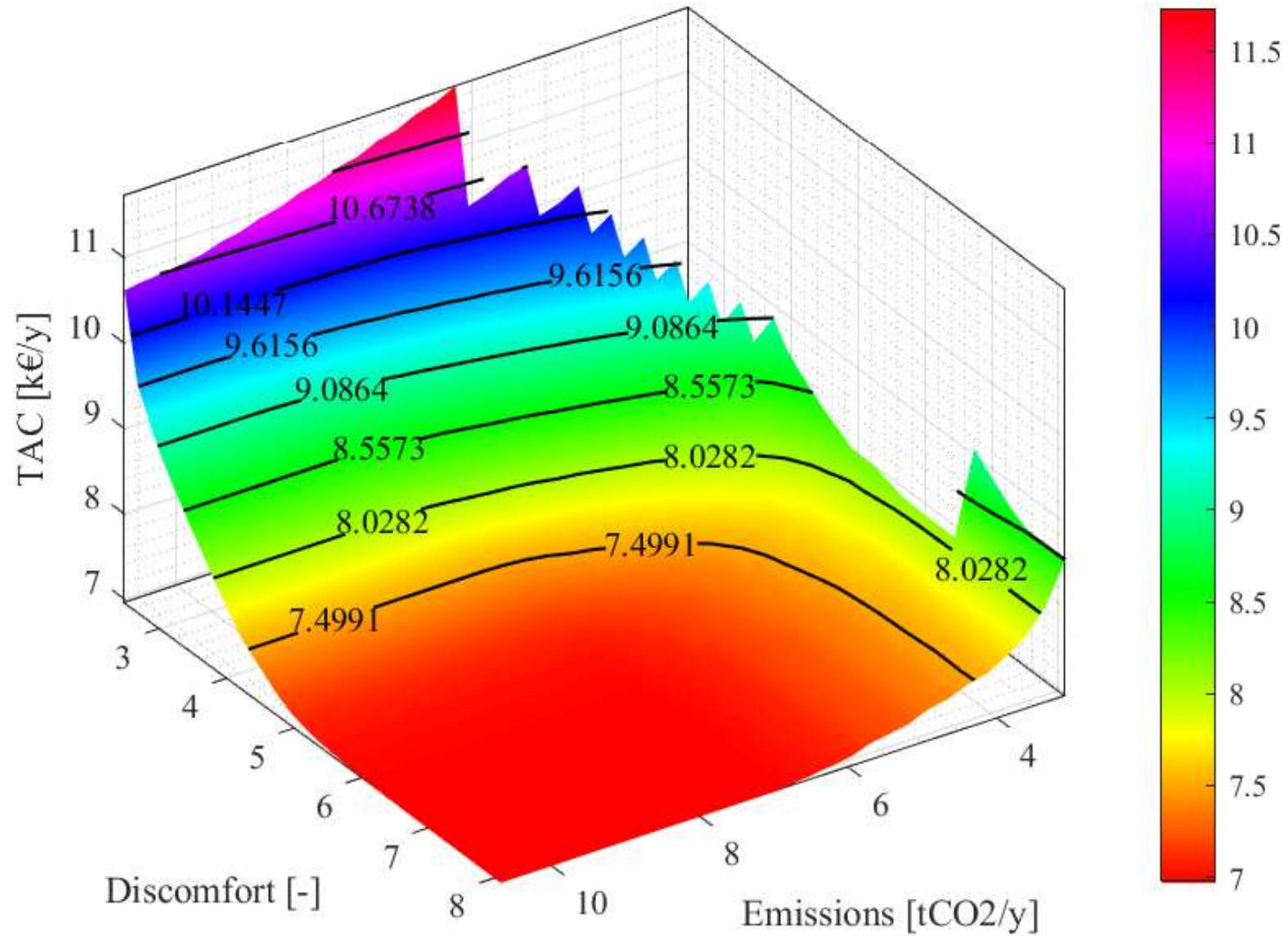



Thank you for your attention!

Davide Fioriti, Dimitri Thomopoulos
DESTEC, University of Pisa